



HMC - Servo drive systems

■ Introduction

Are you looking for a servo drive system satisfying your high expectations of quality and reliability, which was developed using latest technologies and simultaneously improves your machine in economical terms? If so, this catalogue is the right choice for your applications.

Our HeiMotion Compact series of brushless AC servo motors includes eight powerful servo motors and 2 matching motion servo drives families, equipped with different functionalities. Depending on the motor application, you have the choice in between the servo drive familie of HCJ. The components have been developed in Germany and are characterized by precision, robustness and excellent efficiency.

The HeiMotion Compact servo motors are available in three standard frame sizes:

- 60 mm - HMC06
- 80 mm - HMC08
- 130 mm - HMC13

Page forward and find out more details, e.g. about the usage of a durable resolver or about our cost-effective connection solutions.

HeiMotion Compact - the economical drive system for your machine.

■ Contents

General information

Overview	p. 2
Overview motors / servo drives	p. 4
Ambient conditions & technical characteristics	p. 6
Abbreviations & definitions	p. 7
Life span	p. 8
Order code	p. 9

HeiMotion Compact - low inertia motors

HMC06-007	200 W / 230 V	p. 10
HMC06-015	400 W / 230 V	p. 10
HMC08-028	750 W / 230 V	p. 12
HMC08-028	750 W / 400 V	p. 12
HMC08-035	1,000 W / 230 V	p. 14
HMC08-035	1,000 W / 400 V	p. 14

HeiMotion Compact - middle inertia motors

HMC13-055	1,000 W / 230 V	p. 16
HMC13-055	1,000 W / 400 V	p. 16
HMC13-091	1,500 W / 230 V	p. 18
HMC13-091	1,500 W / 400 V	p. 18
HMC13-123	2,000 W / 400 V	p. 20
HMC13-185	3,000 W / 400 V	p. 20

Motor options

Holding brake	p. 22
Resolver	p. 23
Absolute encoder	p. 24
Connectors	p. 26

Servo drives

HCJ servo drive	p. 28
-----------------	-------

Overview

HeiMotion Compact motors basic performance values

	Model	U _{bus} [V _{DC}]	I _o [A]	I _n [A]	M _o [Nm]	M _n [Nm]	M _{max} [Nm]	n _n [rpm]	J [kg-cm ²]	P _n (S1) [W]
Low inertia <i>Low inertia for highest dynamic applications</i>	HMC06-007	320	0.9	0.8	0.7	0.6	2.8	3,000	2.20E-01	200
	HMC06-015	320	1.8	1.5	1.5	1.2	6.0	3,000	4.13E-01	400
	HMC08-028	320	3.1	2.6	2.8	2.4	11.2	3,000	1.40E00	750
		560	1.8	1.6	2.8	2.3	11.2	3,000	1.40E00	750
	HMC08-035	320	3.9	3.7	3.5	3.2	14.0	3,000	1.93E00	1,000
		560	2.2	2.1	3.5	3.2	14.0	3,000	1.93E00	1,000
Middle inertia <i>Balanced inertia for optimized synchronization of load and drive</i>	HMC13-055	320	4.8	4.1	5.5	4.8	22.0	2,000	9.82E00	1,000
		560	2.7	2.3	5.5	4.8	22.0	2,000	9.82E00	1,000
	HMC13-091	320	7.7	6.1	9.1	7.2	36.4	2,000	1.40E01	1,500
		560	4.4	3.4	9.1	7.2	36.4	2,000	1.40E01	1,500
	HMC13-123	560	4.7	4.5	12.3	9.6	49.2	2,000	2.11E01	2,000
	HMC13-185	560	8.4	6.5	18.5	14.4	74.0	2,000	3.38E01	3,000

HeiMotion Compact motors mating servo drives matrix

Type	Model	P _n [W]	n [rpm]	U _{bus} [V _{DC}]	Servo drives HCJ
HMC06	HMC06-007	200	3,000	320	HCJ 22.003
	HMC06-015	400	3,000	320	HCJ 22.003
HMC08	HMC08-028	750	3,000	320	HCJ 22.006
		750	3,000	560	HCJ 24.002
	HMC80-035	1,000	3,000	320	HCJ 22.006
		1,000	3,000	560	HCJ 24.004
HMC13	HMC13-055	1,000	2,000	320	HCJ 22.006
		1,000	2,000	560	HCJ 24.004
	HMC13-091	1,500	2,000	320	HCJ 22.008
		1,500	2,000	560	HCJ 24.007
	HMC13-123	2,000	2,000	560	HCJ 24.007
	HMC13-185	3,000	2,000	560	HCJ 24.012



HCJ
p. 28



General data

Ambient conditions & technical characteristics

Motor type	Permanent magnet three-phase synchronous servo motor	
Ambient operating temperature	- 10 °C to + 40 °C	
Ambient storage temperature	- 20 °C to + 70 °C	
Humidity	< 90 % relative humidity (without condensation)	
Insulation class	F (155 °C) Δ T = 115 K	
Protection class	IP65 (standard version), (except drive end, protection class is IP54, without shaft oil seal)	
Cooling	Natural convective	
Bearing lifetime	20,000 h under rated operation conditions (M _n)	
Voltage slew rate dU/dt	8 kV / μs	
Maximum altitude	4,000 meters above sealevel; derate 1% per 100 meters above 1,000 meters	
Concentricity, coaxiality, and axial run-out	N (normal) per DIN 42955	
Vibration	Stage N in accordance to ISO 2373	
Cogging torque factor c _t	HMC06	< 2.5 % based on the stall torque (M ₀)
	HMC08	< 2.0 % based on the stall torque (M ₀)
	HMC13	< 1.5 % based on the stall torque (M ₀)
Coating	Black top coat, RAL 9005	
Magnet material	Neodymium-Iron-Boron (NdFeB)	
Shaft end	Cylindrical shaft end with / without keyway	
Balancing quality	Q 2.5	
Encoder systems	Resolver, SinCos® SEK/SEL37	
Approvals	CE	

Abbreviations & definitions

Abbr.	Unit	Explanation
f _n	[Hz]	Rated frequency
I ₀	[A _{rms}]	Stall current per phase (motor current at stall torque M ₀)
I _n	[A _{rms}]	Rated current (rated current per phase)
I _{max}	[A _{rms}]	Peak current (maximum permissible current per phase)
J	[kg·cm ²]	Moment of inertia rotor (motor without brake)
k _e	[V _{rms} / krpm]	Voltage constant (induced voltage between two phases at 1,000 rpm) rms (root mean square value)
k _t	[Nm / A _{rms}]	Theoretical torque constant (rms), without losses at 20 °C
L _{p-p}	[mH]	Winding inductance (2 phases) at rated current I _n
m	[kg]	Weight (motor without brake)
M ₀	[Nm]	Stall torque (stall torque at S1)
M _n	[Nm]	Rated torque (continuous torque at S1)
M _{max}	[Nm]	Peak torque (maximum permissible torque for short periods)
n _n	[rpm]	Rated speed
n _{max}	[rpm]	Maximum speed
P _n	[W]	Rated power (mechanical power at the shaft)
R _{p-p}	[Ω]	Winding resistance (2 phases, at winding temperature of 20 °C)
c _t	[%]	Local cogging torque $c_t = \frac{M_{cmax} - M_{cmin}}{M_0} \times 100 \%$
M _{cmax}	[Nm]	Local maximum of the cogging torque
M _{cmin}	[Nm]	Local minimum of the cogging torque
T _{el}	[ms]	Electrical time constant
T _{th}	[min]	Thermal time constant
U _{mot}	[V _{rms}]	Rated motor voltage (2 phases at rated working point), rms
U _{bus}	[V _{DC}]	DC bus voltage

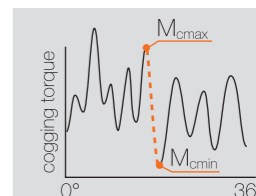

Life span

Shaft loading forces

Life span of the motors is at least 20,000 hours if operated under rated conditions. The table below shows admissible radial forces for the bearing load. Point of force application is in the middle of the shaft (see drawing).

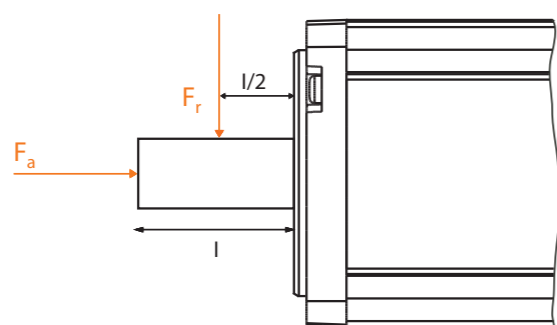

Maximum radial force F_r , [N]

	1,000 [rpm]	2,000 [rpm]	3,000 [rpm]	4,000 [rpm]
HMC06-007	350	290	250	230
HMC06-015	390	310	270	250
HMC08-028	500	400	350	320
HMC08-035	520	410	360	320
HMC13-055	820	650	570	-
HMC13-091	860	680	590	-
HMC13-123	1,100	900	790	-
HMC13-185	1,200	960	840	-

Maximum axial force: $F_a = 0.2 \times F_r$

At stall, a one-time axial force of 40 % of the radial force may be applied during motor mounting. Maximum allowed axial and radial forces must not occur together at the same time.

Order code

HMC08-028-320-30-B0H1M

- Frame / flange size**
 - 60 mm → 06
 - 80 mm → 08
 - 130 mm → 13
- Stall torque**
 - 0.7 Nm → 007
 - 1.5 Nm → 015
 - 2.8 Nm → 028
 - 3.5 Nm → 035
 - 5.5 Nm → 055
 - 9.1 Nm → 091
 - 12.3 Nm → 123
 - 18.5 Nm → 185
- DC bus voltage**
 - 320 V → 320
 - 560 V → 560
- Options**
 - Without Brake 24 V_{DC} → 0XXXX
 - Brake 24 V_{DC} → BXXXX
 - Without Feather key → X0XXX
 - Feather key → XPXXX
 - Resolver → XXR1P
 - SEK 37 → XXH1S
 - SEL 37 → XXH1M
- Rated speed**
 - 2,000 rpm → 20
 - 3,000 rpm → 30

Example: HMC08-028-320-30-B0H1M

- Flange dimension 80 mm
- Rated power 2.8 Nm
- DC bus voltage 320 V
- Rated speed 3,000 rpm
- Options:**
 - With brake
 - Without feather key
 - With SEL 37 encoder

HMC06-007 / -015

200 W / 400 W for 230 V operation

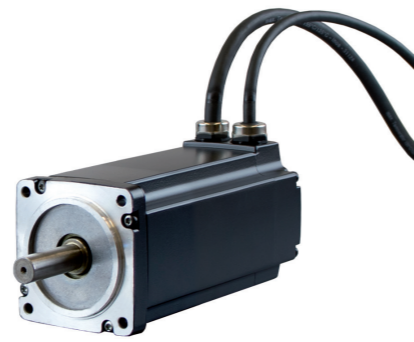

Specifications

		HMC06-007	HMC06-015
Rated speed [rpm]	n_n	3,000	3,000
Number of pole pairs		3	3
Wiring of the motor winding		Y	Y
DC bus voltage [V _{DC}]	U_{bus}	320	320
Rated voltage motor [V _{rms}]	U_{mot}	181	181
Rated power [W]	P_n	200	400
Rated torque [Nm]	M_n	0.6	1.2
Rated current per phase [A _{rms}]	I_n	0.8	1.5
Stall torque [Nm]	M_0	0.7	1.5
Stall current per phase [A _{rms}]	I_0	0.9	1.8
Peak torque [Nm]	M_{max}	2.8	6.0
Peak current [A _{rms}]	I_{max}	3.6	7.2
Maximum speed [rpm]	n_{max}	4,400	4,220
Voltage constant at 1,000 rpm [V _{rms}]	k_e	49.6	51.7
Torque constant [Nm / A _{rms}]	k_t	0.75	0.8
Winding resistance (2 phases) at 20 °C [Ω]	R_{p-p}	26.4	9.8
Winding inductance (2 phases) [mH]	L_{p-p}	37.6	18.6
Electrical time constant [ms]	t_{el}	1.4	1.9
Thermal time constant [min]	t_{th}	25	25
Moment of inertia rotor [kg-cm ²]	J	2.20E-01	4.13E-01
Weight of motor [kg]	m	1.3	1.8

Dimensions

Center bore with axial thread according to DIN 332 - DS M4 (M4 x 10) at C=11 or DS M5 (M5 x 12.5) at C=14

Motor model		L	A	B	Ø C	D	E	F
HMC06-007	without brake	102	30	1.5	11	2	18	4
HMC06-007	with brake	136	30	1.5	11	2	18	4
HMC06-015	without brake	132	30	2	14	3	22	5
HMC06-015	with brake	166	30	2	14	3	22	5

Options	Page	Mating servo drive	HMC06-007	HMC06-015	Page
Brake	22	HCJ 22.003	X	X	28/29
Absolute encoder	24/25				
Connectors	26/27				

Performance

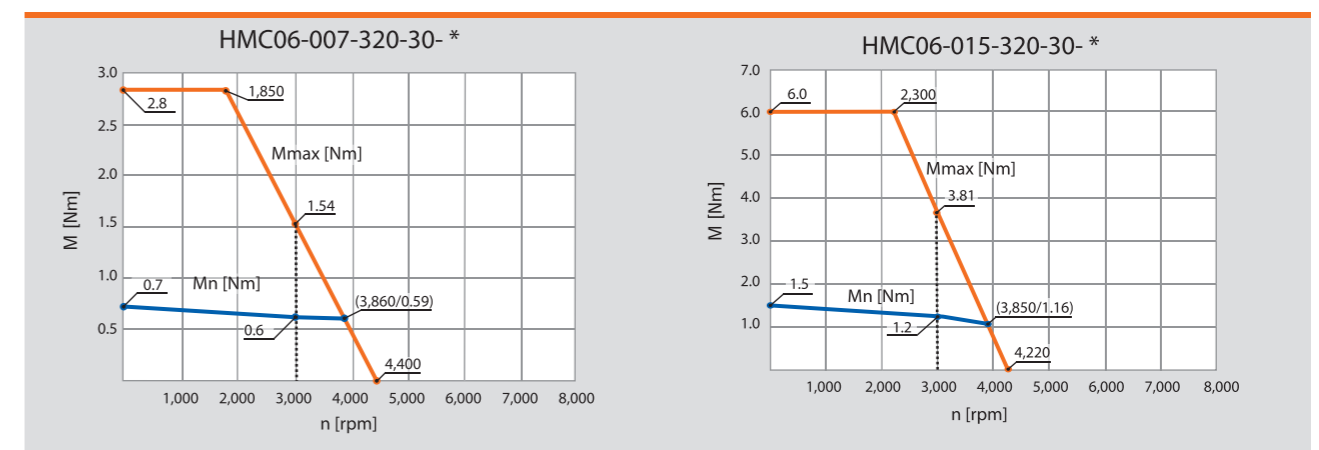

HMC08-028

750 W for 230 V / 400 V operation

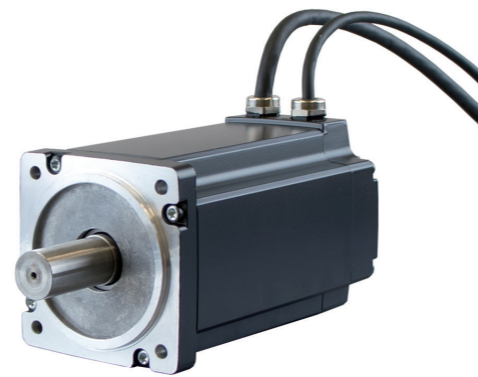

Specifications

		HMC08-028	
Rated speed [rpm]	n_n	3,000	3,000
Number of pole pairs		3	3
Wiring of the motor winding		Y	Y
DC bus voltage [V _{DC}]	U_{bus}	320	560
Rated voltage motor [V _{rms}]	U_{mot}	181	320
Rated power [W]	P_n	750	750
Rated torque [Nm]	M_n	2.4	2.3
Rated current per phase [A _{rms}]	I_n	2.6	1.6
Stall torque [Nm]	M_0	2.8	2.8
Stall current per phase [A _{rms}]	I_0	3.1	1.8
Peak torque [Nm]	M_{max}	11.2	11.2
Peak current [A _{rms}]	I_{max}	12.4	7.2
Maximum speed [rpm]	n_{max}	4,020	3,980
Voltage constant at 1,000 rpm [V _{rms}]	k_e	54.3	95.3
Torque constant [Nm / A _{rms}]	k_t	0.92	1.44
Winding resistance (2 phases) at 20 °C [Ω]	R_{p-p}	4.6	14.2
Winding inductance (2 phases) [mH]	L_{p-p}	11.8	36.2
Electrical time constant [ms]	t_{el}	2.6	2.5
Thermal time constant [min]	t_{th}	30	30
Moment of inertia rotor [kg-cm ²]	J	1.40E00	1.40E00
Weight of motor [kg]	m	2.9	2.9

Dimensions

Center bore with axial thread according to DIN 332 - DS M6 (M6 x 16)

Feather key (option)

Motor model		L	A	B	Ø C	D	E	F
HMC08-028	without brake	136	35	2.5	19	3	22	6
HMC08-028	with brake	178	35	2.5	19	3	22	6

Performance

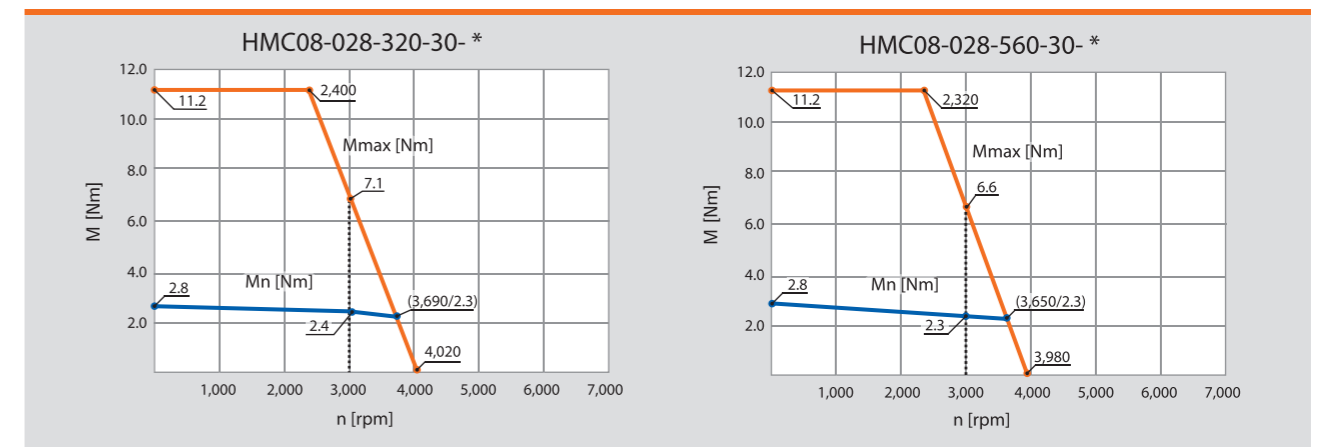

Options	Page	Mating servo drive	HMC08-028-320	HMC08-028-560	Page
Brake	22	HCJ 22.006	X		28/29
Absolute encoder	24/25	HCJ 24.002		X	28/29
Connectors	26/27				

HMC08-035

1,000 W for 230 V / 400 V operation

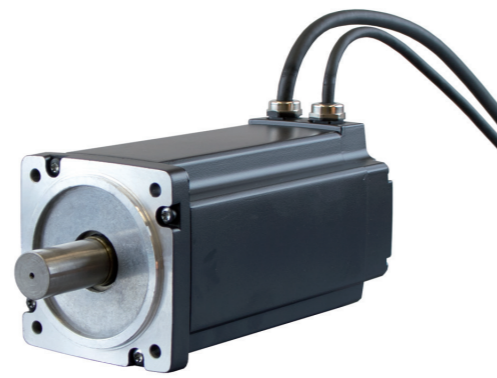

Specifications

		HMC08-035	
Rated speed [rpm]	n_n	3,000	3,000
Number of pole pairs		3	3
Wiring of the motor winding		Y	Y
DC bus voltage [V _{DC}]	U_{bus}	320	560
Rated voltage motor [V _{rms}]	U_{mot}	181	320
Rated power [W]	P_n	1,000	1,000
Rated torque [Nm]	M_n	3.2	3.2
Rated current per phase [A _{rms}]	I_n	3.7	2.1
Stall torque [Nm]	M_0	3.5	3.5
Stall current per phase [A _{rms}]	I_0	3.9	2.2
Peak torque [Nm]	M_{max}	14.0	14.0
Peak current [A _{rms}]	I_{max}	15.6	8.8
Maximum speed [rpm]	n_{max}	3,970	3,890
Voltage constant at 1,000 rpm [V _{rms}]	k_e	55.0	97.5
Torque constant [Nm / A _{rms}]	k_t	0.86	1.52
Winding resistance (2 phases) at 20 °C [Ω]	R_{p-p}	2.8	9.0
Winding inductance (2 phases) [mH]	L_{p-p}	8.4	26.0
Electrical time constant [ms]	t_{el}	3.0	2.9
Thermal time constant [min]	t_{th}	30	30
Moment of inertia rotor [kg-cm ²]	J	1.93E00	1.93E00
Weight of motor [kg]	m	3.6	3.6

Dimensions

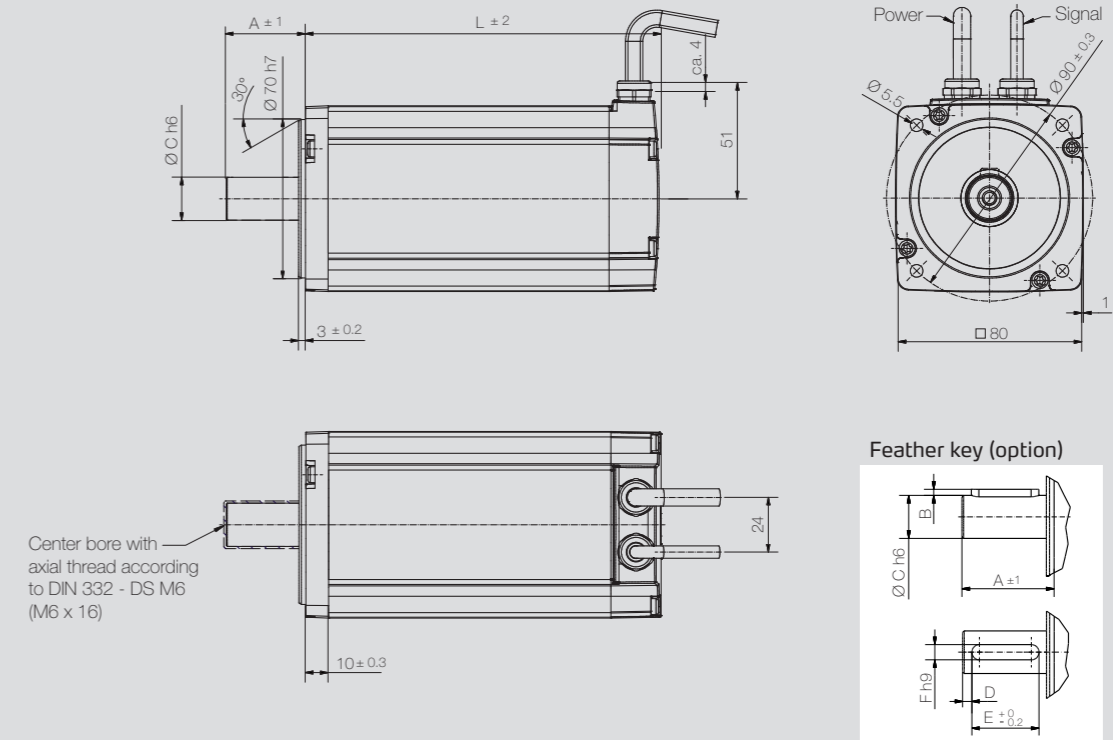

Motor model		L	A	B	Ø C	D	E	F
HMC08-035	without brake	156	35	2.5	19	3	22	6
HMC08-035	with brake	198	35	2.5	19	3	22	6

Options	Page	Mating servo drive	HMC08-035-320	HMC08-035-560	Page
Brake	22	HCJ 22.006	X		28/29
Absolute encoder	24/25	HCJ 24.004		X	28/29
Connectors	26/27				

Performance

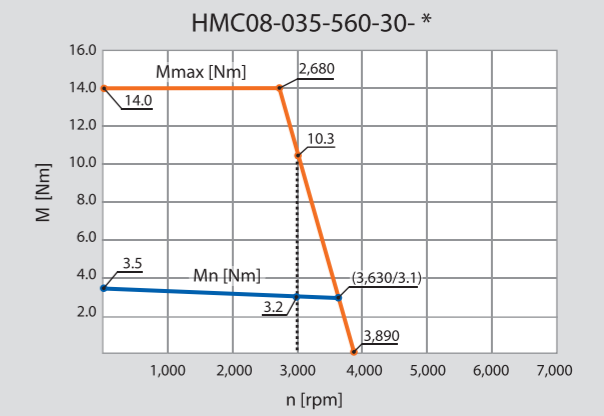
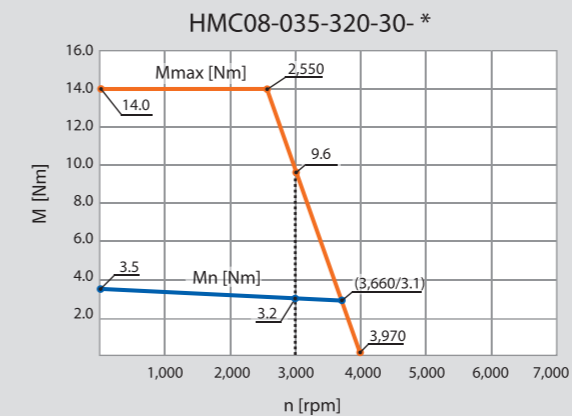

HMC13-055

1,000 W for 230 V / 400 V operation

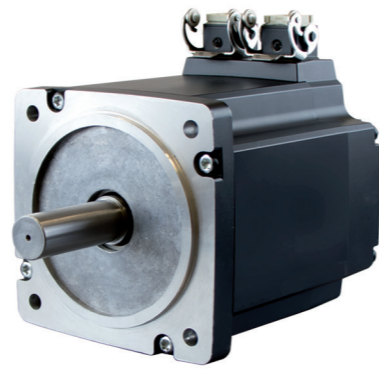

Specifications

		HMC13-055	
Rated speed [rpm]	n_n	2,000	2,000
Number of pole pairs		3	3
Wiring of the motor winding		Y	Y
DC bus voltage [V _{DC}]	U_{bus}	320	560
Rated voltage motor [V _{rms}]	U_{mot}	178	317
Rated power [W]	P_n	1,000	1,000
Rated torque [Nm]	M_n	4.8	4.8
Rated current per phase [A _{rms}]	I_n	4.1	2.3
Stall torque [Nm]	M_0	5.5	5.5
Stall current per phase [A _{rms}]	I_0	4.8	2.7
Peak torque [Nm]	M_{max}	22.0	22.0
Peak current [A _{rms}]	I_{max}	19.0	10.8
Maximum speed [rpm]	n_{max}	2,480	2,340
Voltage constant at 1,000 rpm [V _{rms}]	k_e	85.0	164.0
Torque constant [Nm / A _{rms}]	k_t	1.17	2.09
Winding resistance (2 phases) at 20 °C [Ω]	R_{p-p}	3.5	10.9
Winding inductance (2 phases) [mH]	L_{p-p}	15.0	47.8
Electrical time constant [ms]	t_{el}	3.9	4.2
Thermal time constant [min]	t_{th}	35	35
Moment of inertia rotor [kg-cm ²]	J	9.82E00	9.82E00
Weight of motor [kg]	m	6.9	6.9

Dimensions

Motor model		L	A	B	ØC	D	E	F
HMC13-055	without brake	150	55	3	22	5	40	8
HMC13-055	with brake	180	55	3	22	5	40	8

Options	Page	Mating servo drive	HMC13-055-320	HMC13-055-560	Page
Brake	22	HCJ 22.006	X		28/29
Absolute encoder	24/25	HCJ 24.004		X	28/29
Connectors	26/27				

Performance

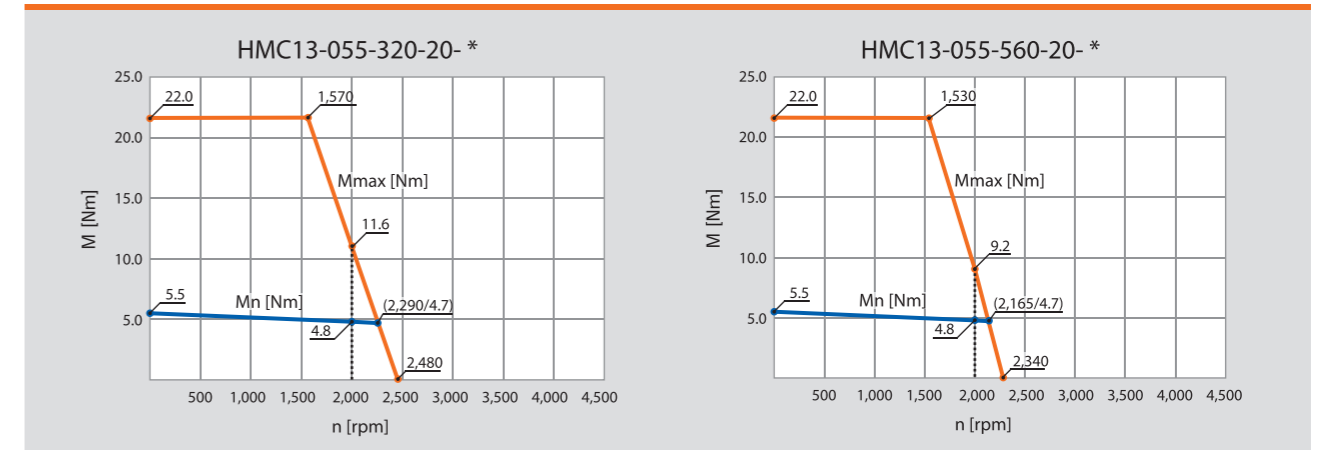

HMC13-091

1,500 W for 230 V / 400 V operation

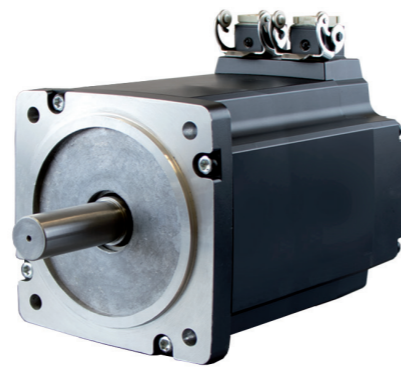

Specifications

		HMC13-091	
Rated speed [rpm]	n_n	2,000	2,000
Number of pole pairs		3	3
Wiring of the motor winding		Y	Y
DC bus voltage [V _{DC}]	U_{bus}	320	560
Rated voltage motor [V _{rms}]	U_{mot}	178	315
Rated power [W]	P_n	1,500	1,500
Rated torque [Nm]	M_n	7.2	7.2
Rated current per phase [A _{rms}]	I_n	6.1	3.4
Stall torque [Nm]	M_0	9.1	9.1
Stall current per phase [A _{rms}]	I_0	7.7	4.4
Peak torque [Nm]	M_{max}	36.4	36.4
Peak current [A _{rms}]	I_{max}	30.8	17.6
Maximum speed [rpm]	n_{max}	2,460	2,440
Voltage constant at 1,000 rpm [V _{rms}]	k_e	89.2	155.0
Torque constant [Nm / A _{rms}]	k_t	1.18	2.12
Winding resistance (2 phases) at 20 °C [Ω]	R_{p-p}	1.9	6.1
Winding inductance (2 phases) [mH]	L_{p-p}	10.3	32.2
Electrical time constant [ms]	t_{el}	4.9	4.9
Thermal time constant [min]	t_{th}	42	42
Moment of inertia rotor [kg-cm ²]	J	1.40E01	1.40E01
Weight of motor [kg]	m	8.5	8.5

Dimensions

Center bore with axial thread according to DIN 332 - DS M8 (M8 x 19)

Feather key (option)

Motor model		L	A	B	Ø C	D	E	F
HMC13-091	without brake	165	55	3	22	5	40	8
HMC13-091	with brake	195	55	3	22	5	40	8

Options	Page	Mating servo drive	HMC13-091-320	HMC13-091-560	Page
Brake	22	HCJ 22.008	X		28/29
Absolute encoder	24/25	HCJ 24.007		X	28/29
Connectors	26/27				

Performance

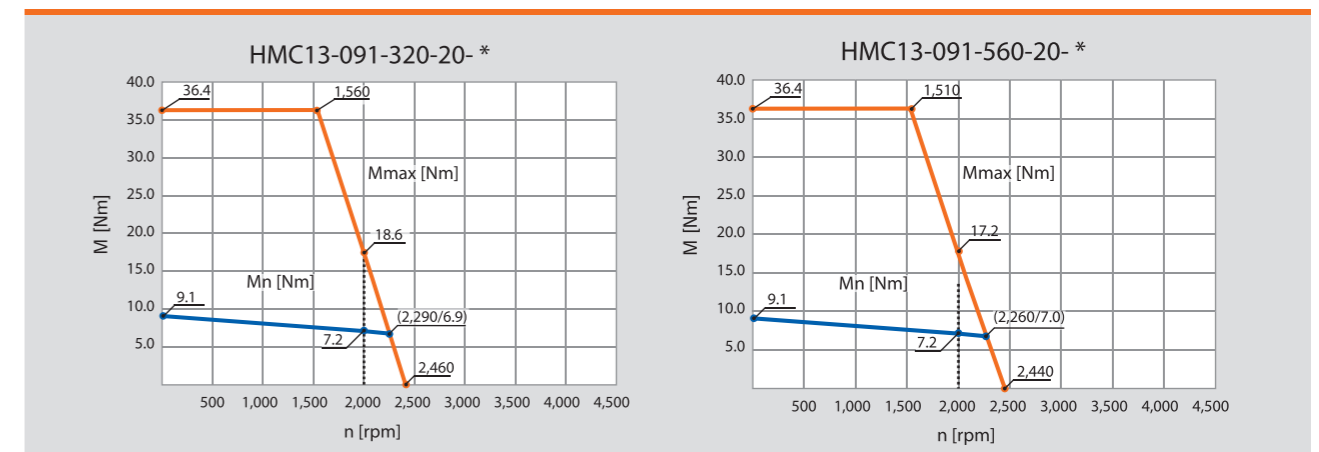

HMC13-123/ -185

2,000 W / 3,000 W for 400 V operation

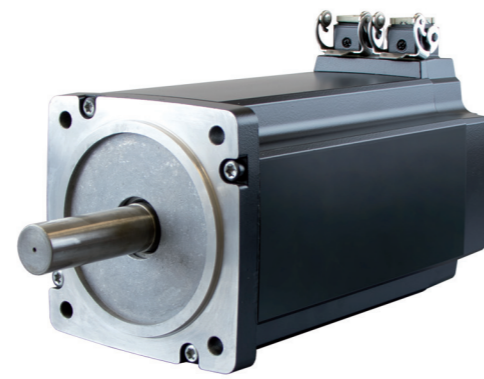

Specifications

		HMC13-123	HMC13-185
Rated speed [rpm]	n_n	2,000	2,000
Number of pole pairs		3	3
Wiring of the motor winding		Y	Y
DC bus voltage [V _{DC}]	U_{bus}	560	560
Rated voltage motor [V _{rms}]	U_{mot}	316	319
Rated power [W]	P_n	2,000	3,000
Rated torque [Nm]	M_n	9.6	14.4
Rated current per phase [A _{rms}]	I_n	4.5	6.5
Stall torque [Nm]	M_0	12.3	18.5
Stall current per phase [A _{rms}]	I_0	4.7	8.4
Peak torque [Nm]	M_{max}	49.2	74.0
Peak current [A _{rms}]	I_{max}	18.8	33.6
Maximum speed [rpm]	n_{max}	2,280	2,410
Voltage constant at 1,000 rpm [V _{rms}]	k_e	161.0	150.0
Torque constant [Nm / A _{rms}]	k_t	2.13	2.21
Winding resistance (2 phases) at 20 °C [Ω]	R_{p-p}	3.6	1.75
Winding inductance (2 phases) [mH]	L_{p-p}	21.2	13.2
Electrical time constant [ms]	t_{el}	5.4	5.4
Thermal time constant [min]	t_{th}	49	49
Moment of inertia rotor [kg-cm ²]	J	2.11E01	3.38E01
Weight of motor [kg]	m	10.6	14.7

Dimensions

Center bore with axial thread according to DIN 332 - DS M8 (M8 x 19)

Feather key (option)

Motor model		L	A	B	Ø C	D	E	F
HMC13-123	without brake	190	55	3	22	5	40	8
HMC13-123	with brake	225	55	3	22	5	40	8
HMC13-185	without brake	235	65	3	24	5	50	8
HMC13-185	with brake	270	65	3	24	5	50	8

Performance

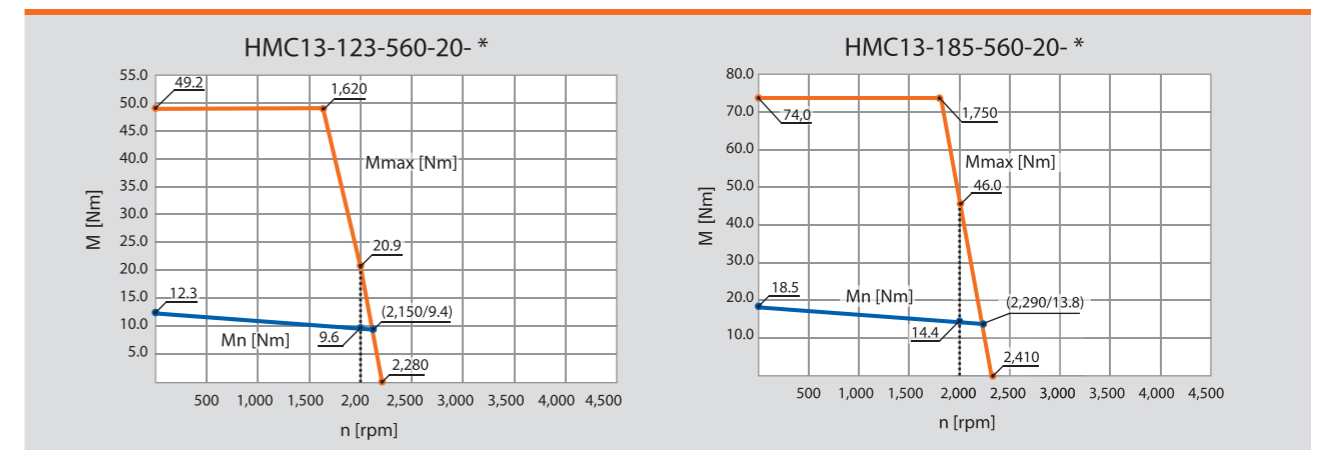

Options	Page	Mating servo drive	HMC13-123-560	HMC13-123-560	Page
Brake	22	HCJ 24.007	X		28/29
Absolute encoder	24/25	HCJ 24.012		X	28/29
Connectors	26/27				

■ Holding brake

Any HeiMotion Compact motor may be equipped with a permanent-magnet DC holding brake.

Insulation class:	F (155 °C)
Maximum speed:	10,000 rpm
Voltage supply:	24 V _{DC} + 6 % / -10 %

Specifications	HMCo6		HMCo8	
	-007	-015	-028	-035
Moment of inertia motor <u>with</u> brake * [kg-cm ²]	3.19E-01	5.12E-01	1.68E00	2.20E00
Static braking torque [Nm]	2.0	2.0	4.5	4.5
Dynamic braking torque [Nm]	1.7	1.7	3.8	3.8
Rated input power [W]	11.0	11.0	12.0	12.0
Working voltage [V _{DC}]	24	24	24	24
Input current brake [A]	0.46	0.46	0.50	0.50
Energy rating [kJ]	580	580	580	580
Separating time brake [ms]	25	25	35	35
Brake delay [ms]	2	2	2	2
Application delay time [ms]	10	10	15	15
Weight of motor <u>with</u> brake * [kg]	1.6	2.2	3.6	4.3
Slipping time ** [s]	0.5	0.5	0.5	0.5
Idle time ** [s]	0.5	0.5	0.5	0.5
Speed ** [min ⁻¹]	200	200	100	100
Cycle quantity ** [-]	5	5	5	5

* Incl. all attachment parts

Specifications	HMC13			
	-055	-091	-123	-185
Moment of inertia motor <u>with</u> brake * [kg-cm ²]	1.05E01	1.48E01	2.31E01	3.58E01
Static braking torque [Nm]	9.0	9.0	20.0	20.0
Dynamic braking torque [Nm]	7.5	7.5	15.0	15.0
Rated input power [W]	18.0	18.0	24.0	24.0
Working voltage [V _{DC}]	24	24	24	24
Input current brake [A]	0.75	0.75	1.00	1.00
Energy rating [kJ]	890	890	1,290	1,290
Separating time brake [ms]	40	40	50	50
Brake delay [ms]	2	2	3	3
Application delay time [ms]	20	20	40	40
Weight of motor <u>with</u> brake * [kg]	7.9	9.3	12.1	16.3
Slipping time ** [s]	0.5	0.5	0.5	0.5
Idle time ** [s]	0.5	0.5	0.5	0.5
Speed ** [min ⁻¹]	100	100	75	75
Cycle quantity ** [-]	5	5	5	5

* Incl. all attachment parts

** In order to ensure the optimum function of the brake at all times, it is recommended that the respective maintenance cycle (refreshment) be carried out when the brake is first put into operation and at four-week intervals.

The motor may not be operated with the brake applied. The brake is designed as a holding brake. An emergency stop of a running motor using the brake is permitted in exceptional cases. The number of emergency stops is limited by the moment of inertia of the entire system.

■ Resolver

Specifications	RE-15
Number of pole pairs	1
Input frequency	10 kHz
Input voltage	7 V _{rms}
Maximum current input	50 mA
Transformation ratio	0.5 ± 10 %
Phase shift (nominal)	3° ± 3°
Ohmic resistance	
Stator winding	(at 25 °C) 70 ± 10 %
Rotor winding	(at 25 °C) 24 ± 10 %
Impedances	
Z _{ro} (no-load impedance rotor)	typ. 86 j 120
Z _{rs} (short-circuit impedance rotor)	typ. 70 j 105
Z _{so} (no-load impedance stator)	typ. 140 j 273
Z _{ss} (short-circuit impedance stator)	typ. 122 j 244
Maximum residual voltage	30 mV
Maximum electrical error	± 10'
Weight	77 g
Protection class	IP 20
Insulation class	F
Insulation test housing / winding	500 V _{AC} / 50 Hz / 1 s
Moment of inertia rotor	15 gcm ²



Environmental

Working environment	IE 32 according to EN 60721-3-3
Operating temperature range	- 55 °C to 155 °C
Vibration according to EN 60068-2-6	100 m/s ² 10 - 150 Hz
Impact strength at	400m/s ² 6 ms
Operating speed max	20,000 rpm

Dimensions

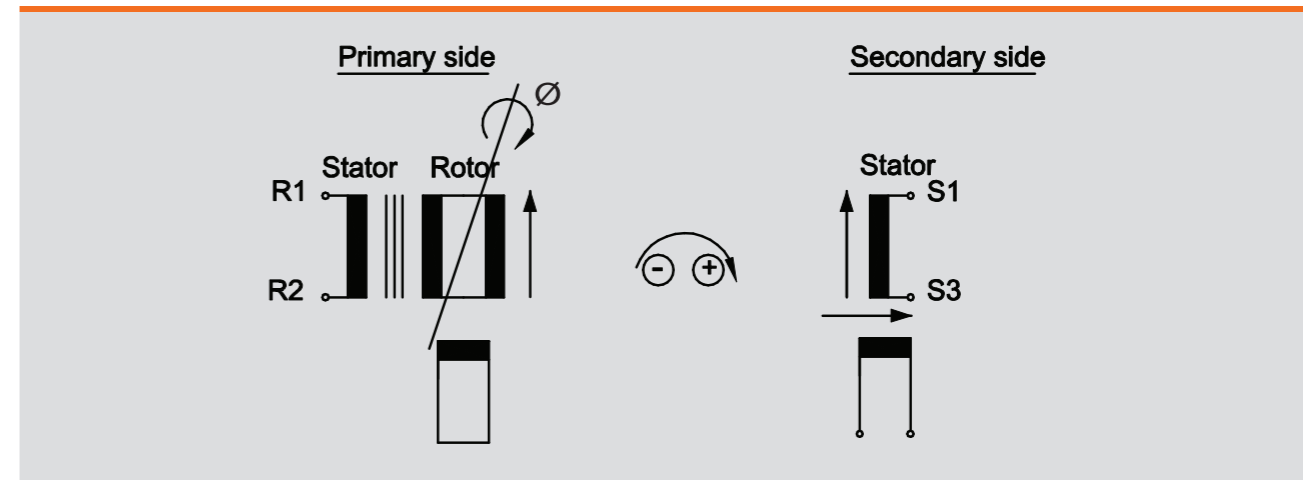

■ Absolute encoder

Our HeiMotion Compact servo motors are supplied in the standard version with a resolver (see page 23). Optionally, singleturn absolute encoder or multiturn absolute encoder with HIPERFACE® can be selected.

Capacitive sensing encoder

SEK / SEL37

(Single- or multi-turn encoder)

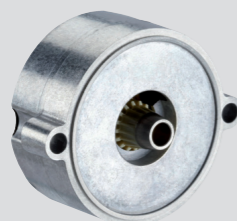

HIPERFACE®
by SICK

Specifications:

- 16 sin/cos periods per revolution
- Absolute position with a resolution of 512 steps per revolution
- Measuring of 4,096 revolutions (multi-turn)
- Programming of the position value
- HIPERFACE®-interface

Signal specification of process data cable

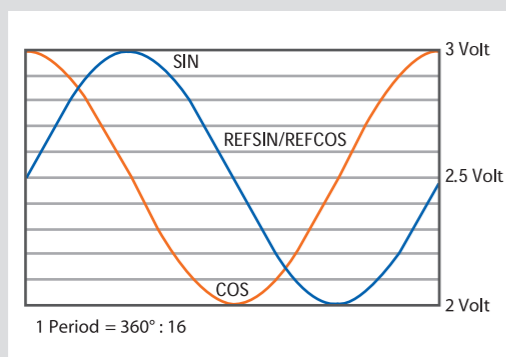

Signal flow clockwise rotation of the shaft, viewed from shaft side (A flange). The access to the process data which are used for speed control, so to the sine and cosine signals, is virtually always „online“. The speed controller has access with no delay to this information. A sophisticated technology guarantees stable amplitudes of the analog signals in all specific environmental conditions to a maximum variation of only +/- 20%.

Specifications (according to DIN 32878)

Single-/multi-turn

Number of sin/cos periods per revolution	16
Maximum number of turns	single SEK 1 multi SEL 4,096
Code type for absolute value	binary
Code sequence ¹⁾	ascending
Measuring step during interpolation of the sin/cos signals (for 12 bit)	20 arc seconds
Maximum sin/cos signals interpretation error, integral non-linearity	± 288 arc seconds
Non-linearity of a sin/cos period differential non-linearity	± 144 arc seconds ²⁾
Resistance to shocks	100 g / 10 ms
Resistance to vibration	50 g / 10...2,000 Hz
Operating voltage range	7...12 V
Recommended supply voltage	8 V
Maximum operating current without load	< 50 mA
Available memory area within EEPROM 2048 ³⁾	1,792 bytes
Interface signals	analog
Process data cable = SIN, REFSIN, COS, REFCOS	differential
Parameter channel = RS 485	digital

1) For rotation of the shaft in clockwise direction when facing in the direction of "A"

2) In the nominal position ± 0.1 mm

3) When using the electronic type plate in operative connection with numerical controls, consider patent EP 425 912 B 2; use in operative connection with speed controllers is excluded from this rule.

Connectors

Cable HMC06/HMC08

The HMC06 and HMC08 motors are connected via a shielded cable with a maximum temperature admissibility of 155 °C for the insulation of the individual wires, and 125 °C for the coat.

Specifications	Power cable	Signal cable
Standard cable length [mm]:	500	500
Shield:	copper wire mesh tinned	copper wire mesh tinned
Conductor (copper, tinned, finely stranded):	6 x 0.75 mm ²	6 x AWG26 (in twisted pairs)
Cable outer diameter [mm]:	7.60 +/- 0.2	5.3 +/- 0.3
Insulation (coat):	Santoprene	PU
Insulation (conductor):	Teflon-FEP	TPE-E
Temperature range moved (S1):	- 25° / + 125°	- 25° / + 125°
Temperature range not moved :	- 40° / + 125°	- 40° / + 125°

Power

Color	Function
brown	Br + *
black	Br - *
yellow	U
orange	V
red	W
green / yellow	PE

* If available

Signal resolver

Color	Function
yellow	cos - / refcos
gray	R2 (ref -)
pink	R1 (ref +)
green	cos +
brown	sin - / refs sin
white	sin +

Signal HIPERFACE®

Color	Function
pink	cos +
white	sin +
black	cos - / refcos
brown	sin - / refs in
red	U _s
blue	GND
gray	Data +
green	Data -

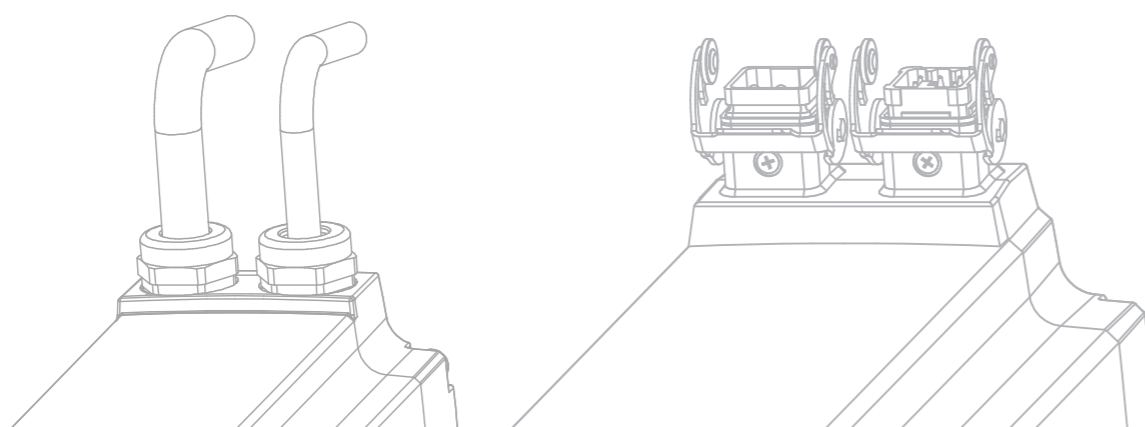

Connector HMC13

The HMC13 motors are in standard equipped with connectors. The mating connector is not included in the standard version.

Pin assignments on the motor

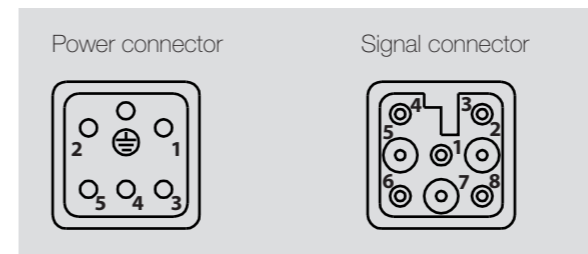

Dimensions

connector and mating connector

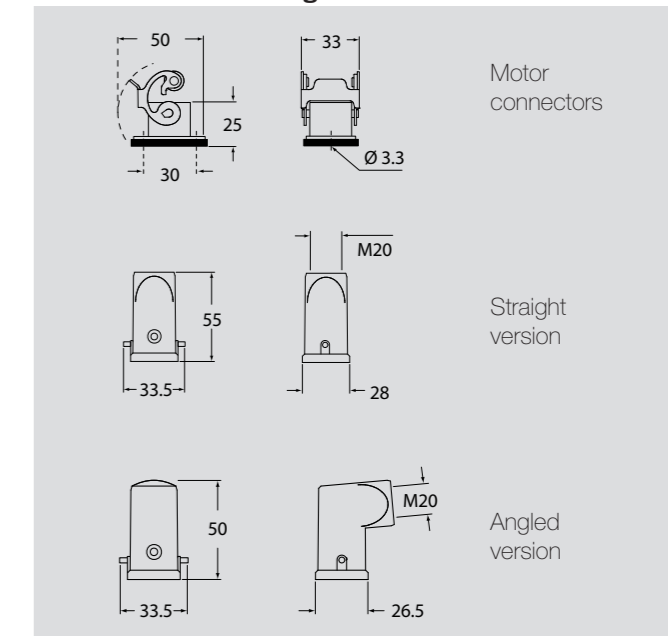

Power

Pin	Function
1	U
2	V
3	W
4	Br + *
5	Br - *
Grounding	PE

* If available

Signal resolver

Pin	Function
1	cos +
2	sin +
3	cos - / refcos
4	sin - / refs in
5	R1 (ref +)
6	R2 (ref -)

Signal HIPERFACE®

Pin	Function
1	cos +
2	sin +
3	cos - / refcos
4	sin - / refs in
5	U _s
6	GND
7	data +
8	data -

Mating connector in socket execution (EMV-compliant)

Version	Connector Description	Part Number
straight version	Signal connector, without cable **	11-018-014-22-0
	Signal connector, 1,500 mm cable	14-007-039-45-0
	Signal connector, 5,000 mm cable	14-007-039-49-0
	Power connector, without cable **	11-018-014-21-0
angled version	Signal connector, without cable **	11-018-014-24-0
	Signal connector, 1,500 mm cable	14-007-039-51-0
	Signal connector, 5,000 mm cable	14-007-039-53-0
	Power connector, without cable **	11-018-014-23-0
	Power connector, 1,500 mm cable	14-007-039-50-0
	Power connector, 5,000 mm cable	14-007-039-52-0

** All variants without cables are attached in loose kits, dedicated tools are needed for assembly.

Connector set is enclosed as a bag. Please use the corresponding order codes.

HCJ drive, 230 / 400 V_{AC}



Specifications servo drive

Typ	DC bus voltage	Input voltage	Continuous output current I_N	Maximum output current I_{MAX}	Frame size
	[V]	[V]	[A _{rms}]	[A _{rms}]	
HCJ22.003	325	1 / 3 x 230	3	9	size 2
HCJ24.002	560	3 x 400	2	6	size 2
HCJ22.006	325	1 / 3 x 230	5.9	17.7	size 3
HCJ24.004	560	3 x 400	3.5	10.5	size 3
HCJ22.008	325	1 / 3 x 230	8	24	size 4
HCJ24.007	560	3 x 400	6.5	19.5	size 4
HCJ24.012	560	3 x 400	12	36	size 5
HCJ24.016	560	3 x 400	16	48	size 5

Mains frequency [Hz] 50 / 60 ± 10 %

size 2/3/4

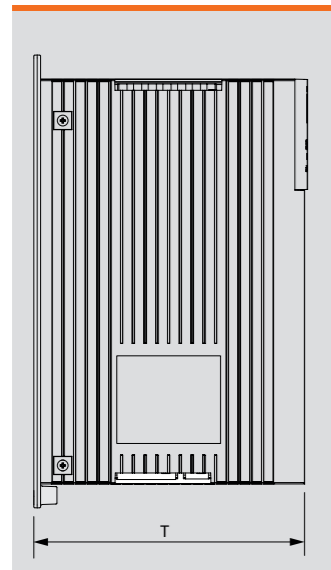

Type	T	Weight
size 2	142 mm	1.0 kg
size 3	189 mm	1.5 kg
size 4	235.5 mm	2.8 kg
size 5	235.5 mm	5.5 kg / 5.9 kg

size 2/3

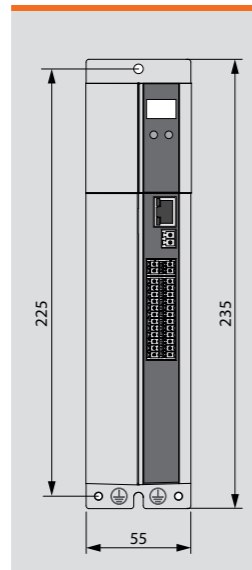

size 4

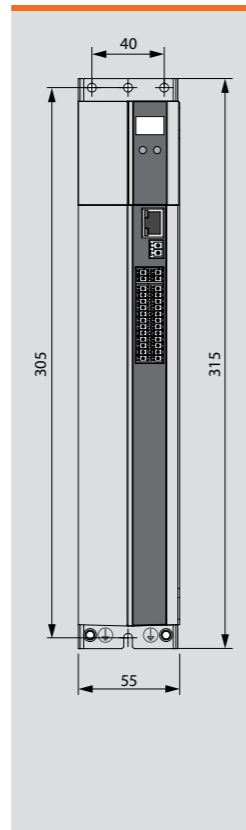

size 5

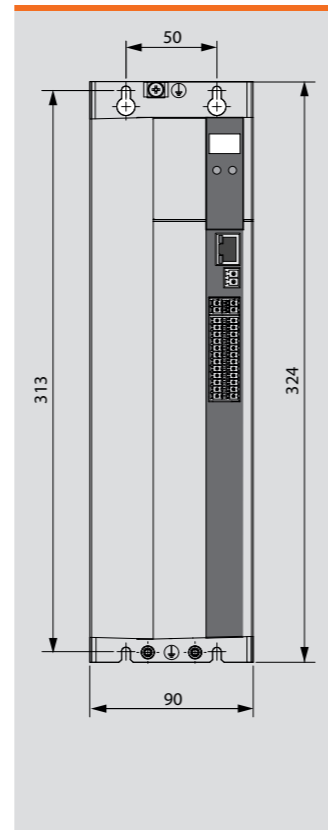

Connections / inputs and outputs

Connection	Name	Function
X1	Plug-in terminal (7-pole)	Motor phases (U/V/W/PE) DC-link (L+/L-) Brake resistor (L+/RB)
X2	Plug-in terminal (2-pole)	Logic supply + 24 V _{DC}
X3	Plug-in terminal (4-pole)	Mains supply (L1/L2/L3/PE)
X4	Plug-in terminal (2x 10-pole)	7 digital inputs 2 analog inputs (10-bit ADC) 3 digital outputs 1 relay (24 V / 1 A) diagnosis STO
X5	Plug-in terminal (2-pole)	Temperature monitoring (PTC / KTY / Klixon)
X6	D-sub connector (9-pole)	Interface for resolver
X7	D-sub connector (15-pole)	Interface for rotary encoders (TTL / SSI / HIPERFACE / ENDAT)
X9	RJ-45 connector	Interface for Ethernet
X13	Plug-in terminal (4-pole)	Interface for motor brake
Option 1	Connector (depending on module)	Fieldbus interface e.g. CANopen, EtherCAT, SERCOS, ...
Option 2	Connector (depending on module)	Encoder interface e.g. second (safe) encoder, Encoder simulation, TwinSync, axis monitoring, ...

Ambient conditions

Ambient temperature in operation:	- 10 °C ... + 40 °C
Storage temperature:	- 25 °C ... + 55 °C
Operating and storage humidity:	< 85 % relative humidity (without condensation)
Protection class:	IP20 except clamps (IP00)
Installation altitude:	up to 1,000 m

Supported encoder systems

Resolver, HIPERFACE® encoder, HIPERFACE DSL® encoder, Incremental encoder, SSI absolute encoder, EnDat 2.2 encoder

Interface

CANopen (CiA 402), Ethernet (parameterization via DriveManager software)

Optional: EtherCAT, SERCOS III, Profibus DP or Profinet IRT

Functions

- PLC Motion
- Brake driver
- Sequenced driving set positioning
- Online position profile generator
- DriveManager software
- Integrated braking resistor (size 3+4)
- Safe stop according to EN 954-1, category 3
- Radio interference filters (RFI) up to 7.5 kW
- Electronic cam

Technical data subject to change! Last changes: 01/2021



Heidrive GmbH

Starenstraße 23
D-93309 Kelheim

Phone +49 9441/707-0

Fax +49 9441/707-259

info@heidrive.com

www.heidrive.com